

Directional valve 3-way/2-position

$Q_{max} = 40 \text{ l/min}$, $p_{max} = 315 \text{ bar}$

direct acting, poppet type, mechanical operation

Type series: W1U.../ W1X... (installation shallow)



- Slip-in cartridge valve
- For cavity AC
- All external parts with zinc-nickel plating according to DIN EN ISO 19598
- Guided valve spool and poppet
- Seat tight shut-off
- Hand lever with or without detent feature

Description

The 3-way/2-position solenoid-operated directional seat valves, series W1U... / W1X... (installation shallow), are size 6, direct acting, and pressure balanced screw-in valves. In the normal condition (non-operated), flow in port 1 is shut off without leakage. They are designed on the tried and tested principle of the guided poppet, and the guide spool has a seal. This valve type has an underlapped spool. In the crossover position, all connections are thus connected, i.e., there is a connection between ports 1, 2 and 3 during the valve's switching period. This type is the "shallow" installation version, which fits into the cavity type according to the AC factory standard. For the "deep" installation version, see separate data sheet. The hand

lever can be turned through 360° and is available as a "detentable" (W1U...) or "non-detentable" (W1X...) model. All external parts of the cartridge are zinc-nickel plated, and are thus suitable for use in the harshest operating environments. The slip-on coils can be replaced without opening the hydraulic envelope and can be positioned at any angle through 360°. These valves are predominantly used in certain mobile and industrial applications where leak-tight shut-off functions are crucially important. Examples are where loads, tensions, or clamping forces must be held without leakage. For self-assembly, please refer to the section related data sheets.

Symbol

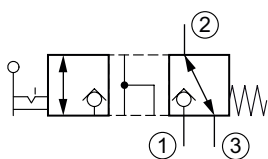

W1U...

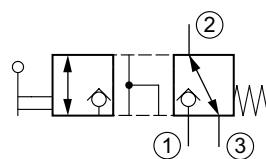

W1X...

Technical data

General characteristics	Description, value, unit
Function group	Directional valve
Function	3-way/2-position
Design	Slip-in cartridge valve
Controls	mechanical operation
Characteristic	direct acting, poppet type
Transition/central position of spool/piston	zero or underlap/negative (open)
Construction size	nominal size 6
Mounting attitude	unrestricted
Weight	0.55 kg
Cavity acc. factory standard	For cavity AC
Tightening torque steel	5.2 Nm
Tightening torque aluminium	5.2 Nm
Tightening torque tolerance	± 5 %
Minimum ambient temperature	- 25 °C
Maximum ambient temperature	+ 80 °C
Surface protection	All external parts with zinc-nickel plating according to DIN EN ISO 19598
Sealing material	see ordering code
Seal kit order number	NBR: DS-387-N / FKM: DS-387-V

Hydraulic characteristics	Description, value, unit
Maximum operating pressure	315 bar
Maximum flow rate	40 l/min
Flow direction	see symbol
Hydraulic fluid	HL and HLP mineral oil according to DIN 51 524; other fluids on request!
Minimum fluid temperature	- 25 °C
Maximum fluid temperature	+ 80 °C
Viscosity range	10 ... 500 mm ² /s (cSt)
Recommended viscosity range	15 ... 250 mm ² /s (cSt)
Minimum fluid cleanliness (cleanliness class according to ISO 4406:1999)	class 20/18/15

Mechanical characteristics	Description, value, unit
Execution	with hand lever, can be turned through 360°
Actuation angle	15 °

Performance graphs

measured with oil viscosity 33.0 mm²/s (cSt)

$p = f(Q)$ Performance limit

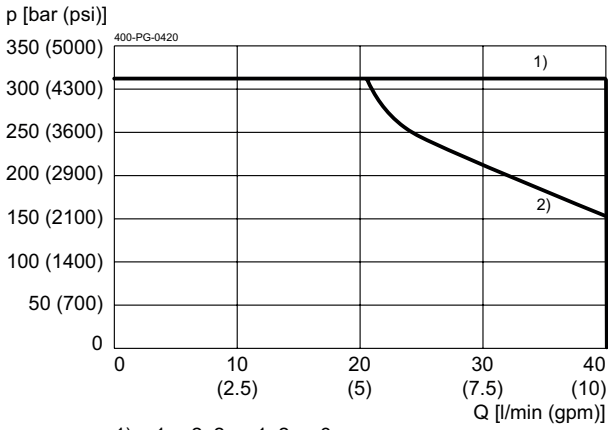

- 1) = 1 → 2, 2 → 1, 2 → 3
- 2) = 3 → 2

$\Delta p = f(Q)$ Pressure drop-flow rate characteristic

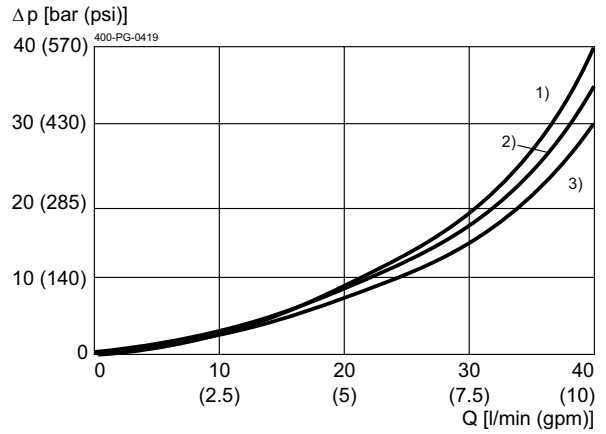

- 1) = 2 → 1; 2 → 3
- 2) = 1 → 2
- 3) = 3 → 2

Dimensions and sectional view

Beispiel für die Masseinheit:
Example for the dimensional units:

0.79 = 0.79 mm millimeter
(.031) = 0.031" inch

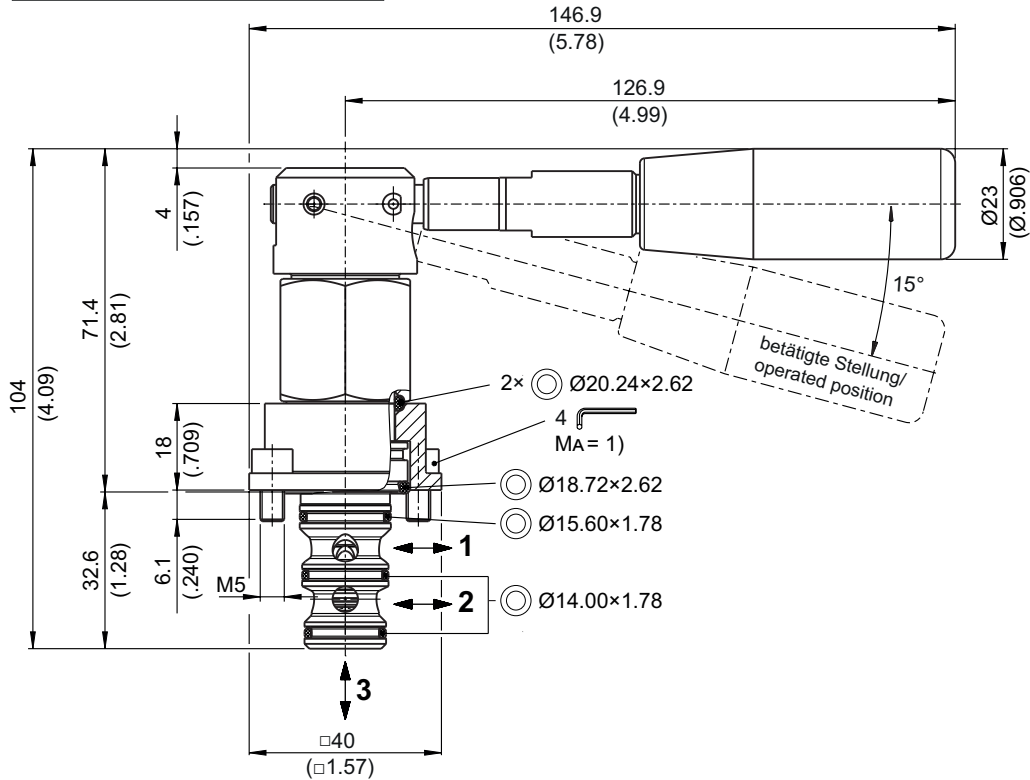

Installation information



ATTENTION!

Only qualified personnel with mechanical skills may carry out any maintenance work. Generally, the only work that should ever be undertaken is to check, and possibly replace, the seals. When changing seals, oil or grease the new seals thoroughly before fitting them.



NOTE!

1) When fitting the slip-in valves, use the specified tightening torque for the mounting screws. The value can be found in the chapter "Technical data".

Functional principle / Spool variants

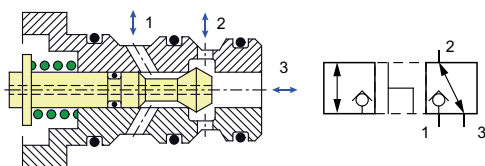

Ordering code

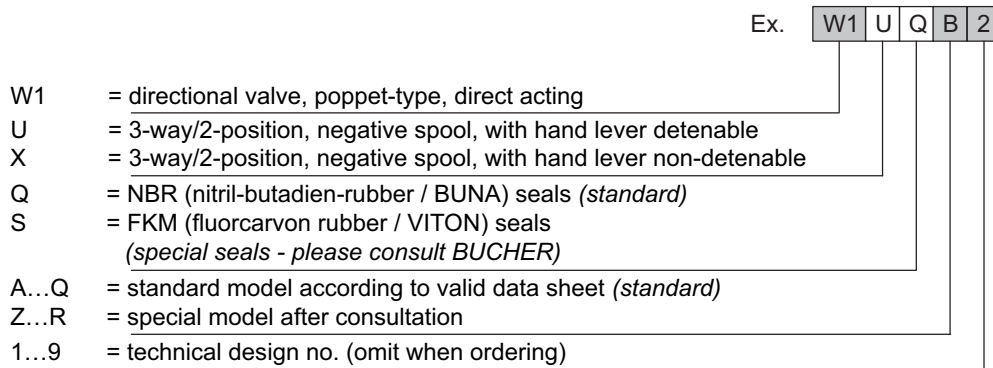

Related data sheets

Reference	Description
400-P-040011	Form tools
400-P-040111	Cavity AC
400-P-730121	Threaded port body GADA